

# SKiiP 16GH066V1



MiniSKiiP<sup>®</sup>1

## H-bridge inverter

### SKiiP 16GH066V1

#### Features

- Trench IGBTs
- Robust and soft freewheeling diode in CAL technology
- Highly reliable spring contacts for electrical connection
- UL recognised file no. E63532

#### Typical Applications\*

- Single-phase inverter up to 9.5 kVA
- Single-phase motor power 4 kW

#### Remarks

- Case temperature limited to  $T_C = 125^\circ\text{C}$
- Product reliability results are valid for  $T_j = 150^\circ\text{C}$
- SC data:  $t_p \leq 6 \mu\text{s}$ ;  $V_{GE} \leq 15 \text{ V}$ ;  $T_j = 150^\circ\text{C}$ ;  $V_{CC} = 360 \text{ V}$
- $V_{CEsat}$ ,  $V_F$  = chip level value

Absolute Maximum Ratings		$T_S = 25^\circ\text{C}$ , unless otherwise specified	
Symbol	Conditions	Values	Units
<b>IGBT - Inverter</b>			
$V_{CES}$		600	V
$I_C$	$T_S = 25 (70)^\circ\text{C}, T_j = 150^\circ\text{C}$	59 (40)	A
$I_C$	$T_S = 25 (70)^\circ\text{C}, T_j = 175^\circ\text{C}$	65 (49)	A
$I_{CRM}$	$t_p = 1 \text{ ms}$	100	A
$V_{GES}$		$\pm 20$	V
$T_j$		-40...+175	$^\circ\text{C}$
<b>Diode - Inverter</b>			
$I_F$	$T_S = 25 (70)^\circ\text{C}, T_j = 150^\circ\text{C}$	47 (31)	A
$I_F$	$T_S = 25 (70)^\circ\text{C}, T_j = 175^\circ\text{C}$	56 (40)	A
$I_{FRM}$	$t_p = 1 \text{ ms}$	100	A
$T_j$		-40...+175	$^\circ\text{C}$
$I_{RMS}$	per power terminal (20 A / spring)	60	A
$T_{stg}$	$T_{op} \leq T_{stg}$	-40...+125	$^\circ\text{C}$
$V_{isol}$	AC, 1 min.	2500	V

Characteristics		$T_S = 25^\circ\text{C}$ , unless otherwise specified			
Symbol	Conditions	min.	typ.	max.	Units
<b>IGBT - Inverter</b>					
$V_{CEsat}$	$I_{Cnom} = 50 \text{ A}, T_j = 25 (150)^\circ\text{C}$	1,05	1,45 (1,65)	1,85 (2,05)	V
$V_{GE(th)}$	$V_{GE} = V_{CE}, I_C = 1 \text{ mA}$		5,8		V
$V_{CE(TO)}$	$T_j = 25 (150)^\circ\text{C}$		0,9 (0,8)	1,1 (1)	V
$r_T$	$T_j = 25 (150)^\circ\text{C}$		11 (17)	15 (21)	m $\Omega$
$C_{ies}$	$V_{CE} = 25 \text{ V}, V_{GE} = 0 \text{ V}, f = 1 \text{ MHz}$		2,87		nF
$C_{oes}$	$V_{CE} = 25 \text{ V}, V_{GE} = 0 \text{ V}, f = 1 \text{ MHz}$		0,6		nF
$C_{res}$	$V_{CE} = 25 \text{ V}, V_{GE} = 0 \text{ V}, f = 1 \text{ MHz}$		0,46		nF
$R_{CC'+EE'}$	spring contact-chip $T_S = 25 (150)^\circ\text{C}$				m $\Omega$
$R_{th(j-s)}$	per IGBT		0,95		K/W
$t_{d(on)}$	under following conditions		40		ns
$t_r$	$V_{CC} = 300 \text{ V}, V_{GE} = -8\text{V}/+15\text{V}$		40		ns
$t_{d(off)}$	$I_{Cnom} = 50 \text{ A}, T_j = 150^\circ\text{C}$		425		ns
$t_f$	$R_{Gon} = R_{Goff} = 18 \Omega$		40		ns
$E_{on}(E_{off})$	inductive load		1,7 (1,7)		mJ
<b>Diode - Inverter</b>					
$V_F = V_{EC}$	$I_{Fnom} = 50 \text{ A}, T_j = 25 (150)^\circ\text{C}$		1,5 (1,5)	1,7 (1,7)	V
$V_{(TO)}$	$T_j = 25 (150)^\circ\text{C}$		1 (0,9)	1,1 (1)	V
$r_T$	$T_j = 25 (150)^\circ\text{C}$		10 (12)	12 (14)	m $\Omega$
$R_{th(j-s)}$	per diode		1,6		K/W
$I_{RRM}$	under following conditions		44		A
$Q_{rr}$	$I_{Fnom} = 50 \text{ A}, V_R = 300 \text{ V}$		5,5		$\mu\text{C}$
$E_{rr}$	$V_{GE} = 0 \text{ V}, T_j = 150^\circ\text{C}$		1,3		mJ
	$di_F/dt = 1400 \text{ A}/\mu\text{s}$				
<b>Temperature Sensor</b>					
$R_{ts}$	3 %, $T_r = 25 (100)^\circ\text{C}$		1000(1670)		$\Omega$
<b>Mechanical Data</b>					
m			35		g
$M_s$	Mounting torque	2		2,5	Nm

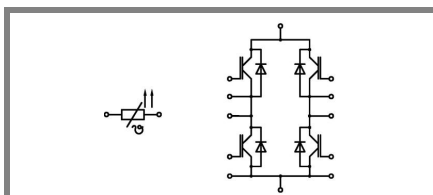

GH

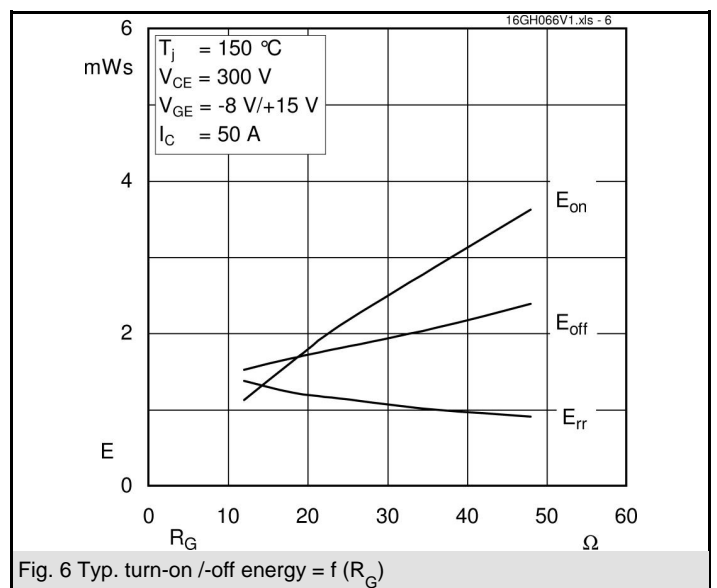
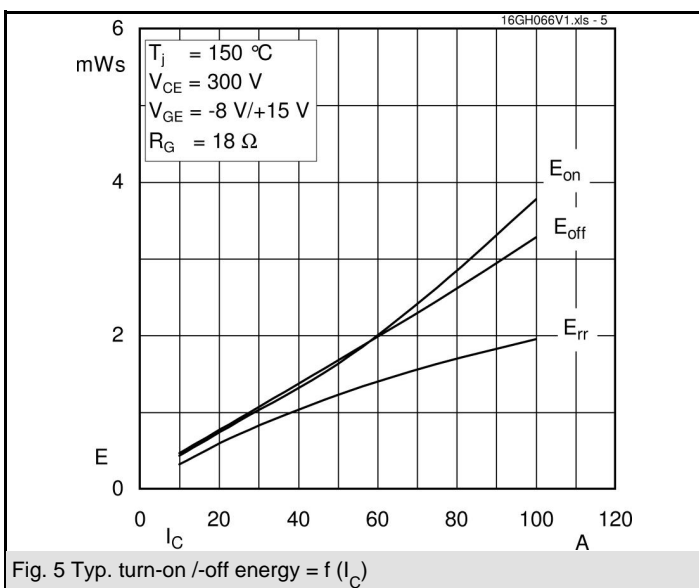
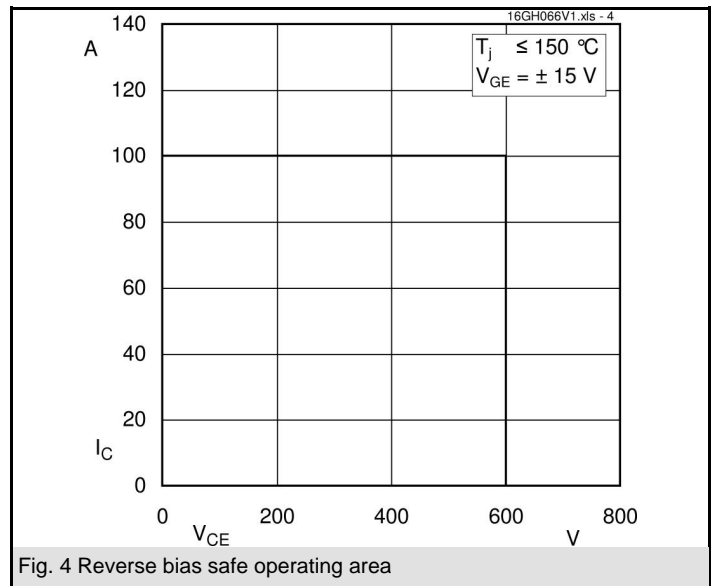
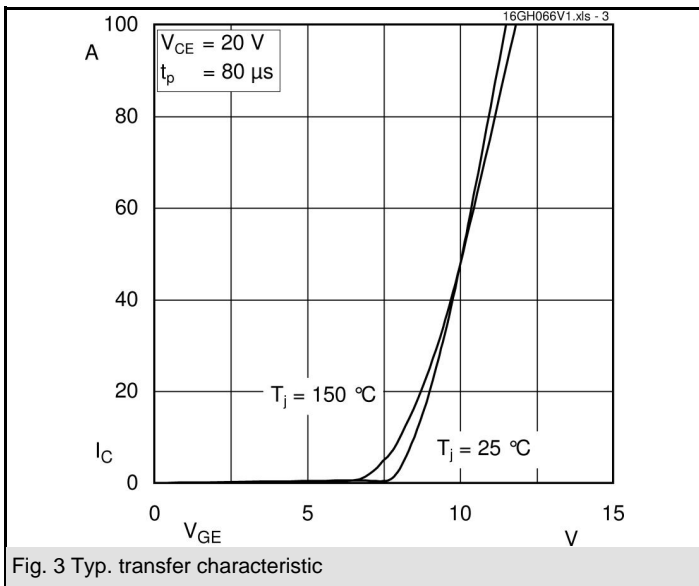
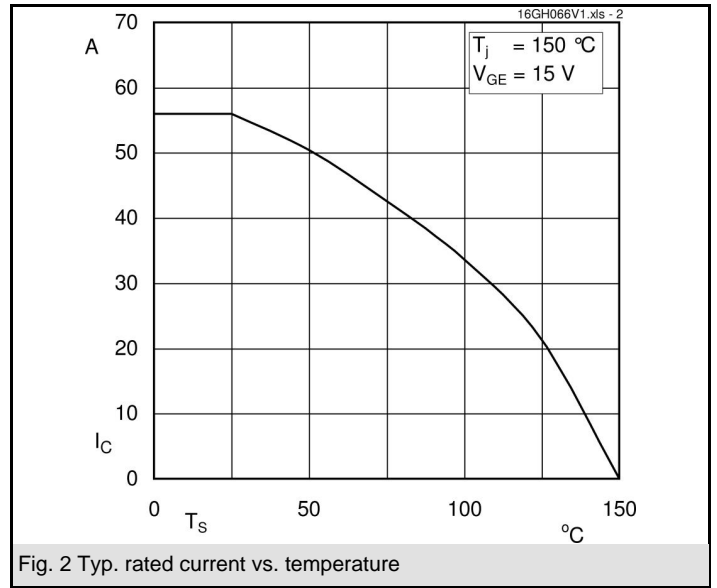
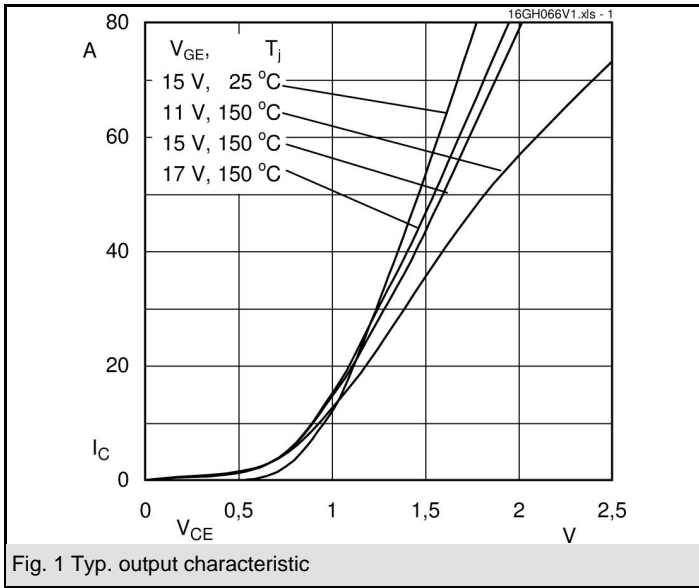

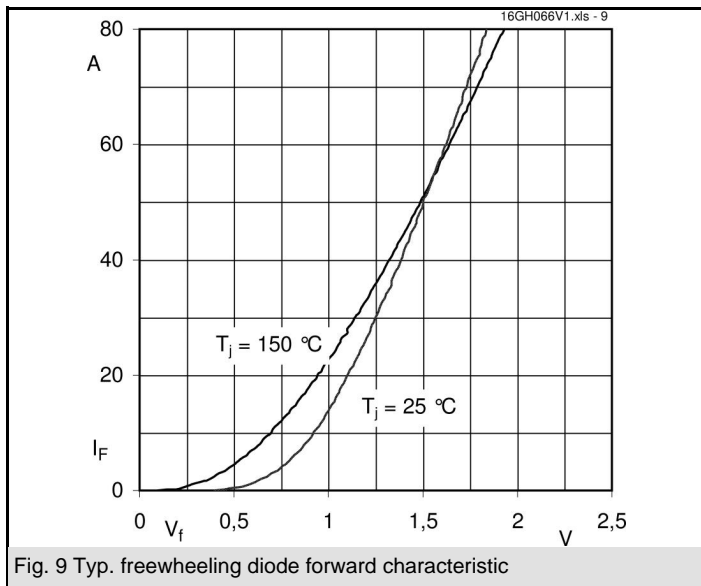
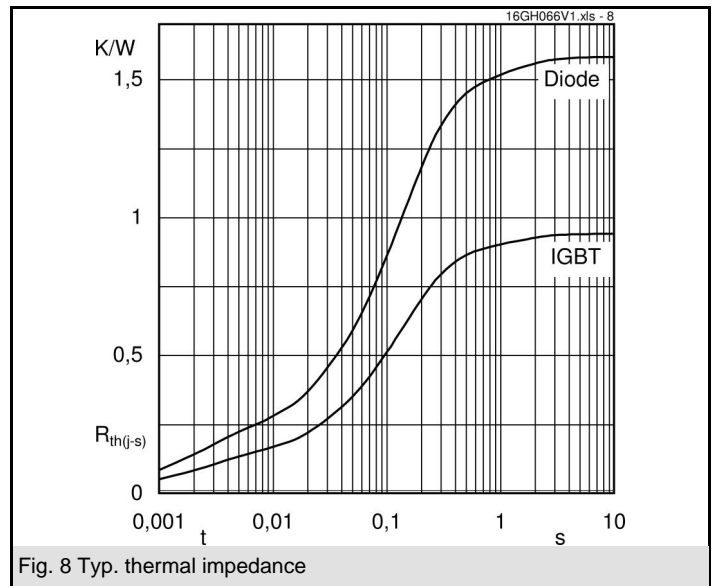
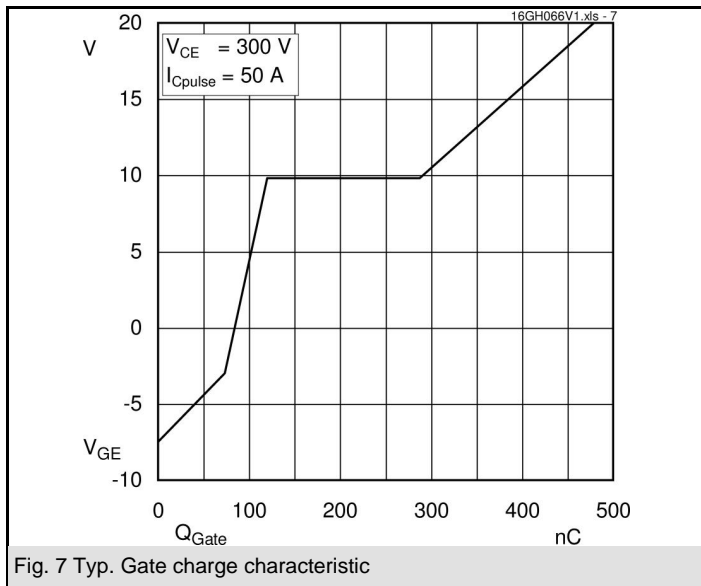

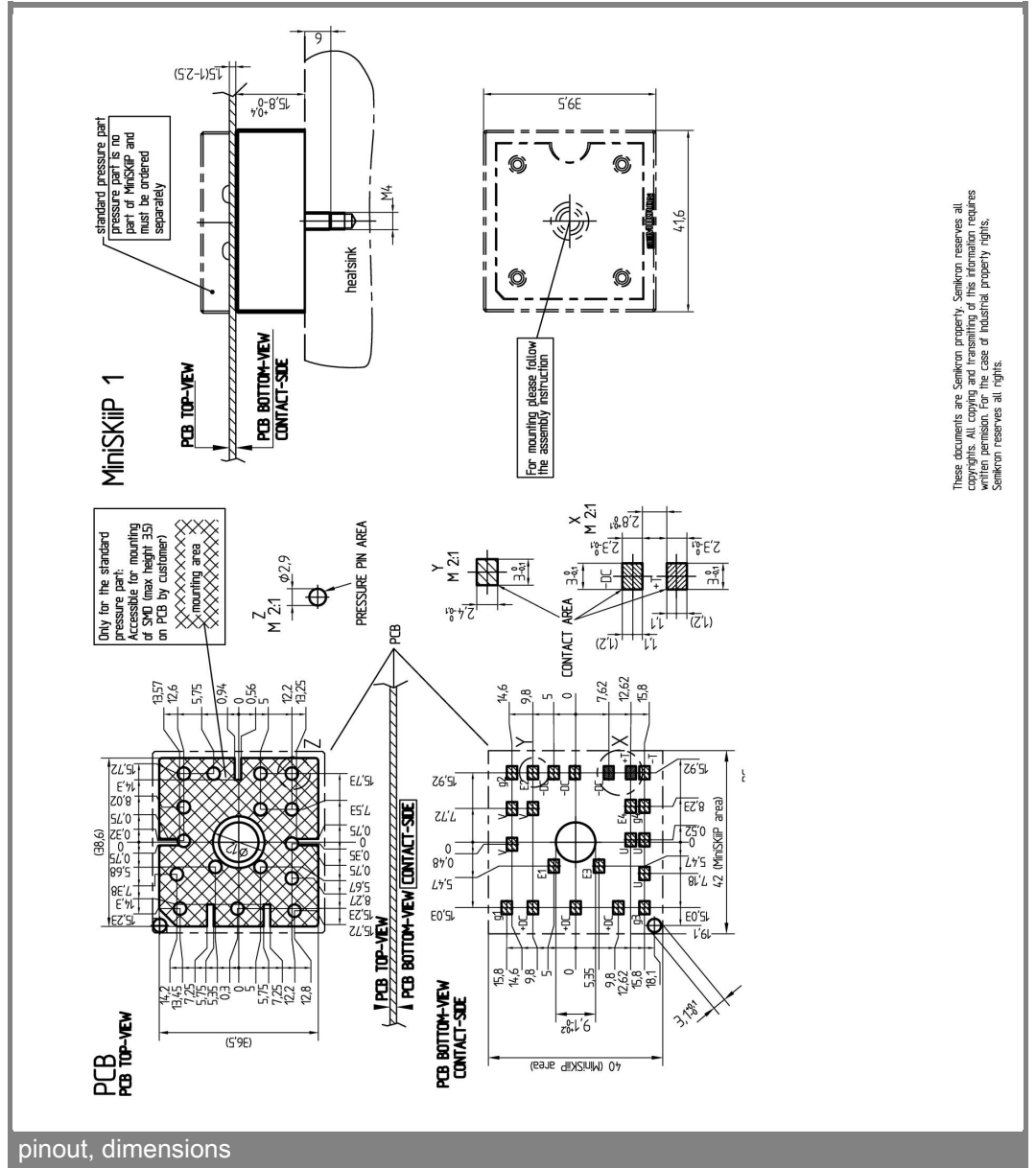
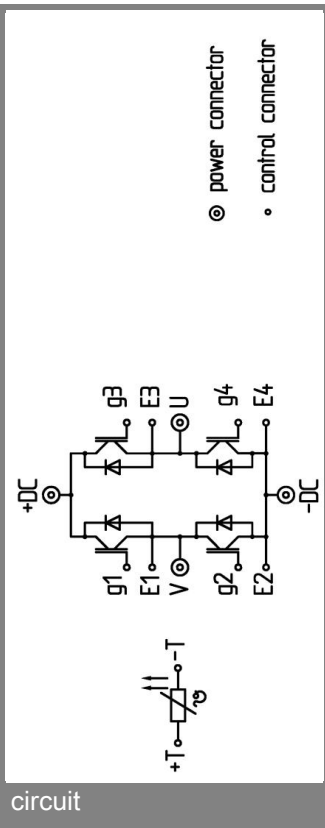

This is an electrostatic discharge sensitive device (ESDS), international standard IEC 60747-1, Chapter IX.

\* The specifications of our components may not be considered as an assurance of component characteristics. Components have to be tested for the respective application. Adjustments may be necessary. The use of SEMIKRON products in life support appliances and systems is subject to prior specification and written approval by SEMIKRON. We therefore strongly recommend prior consultation of our personal.